

Article number: 4395000651

Description: Rota-fix shaft-hub connection F65x95
Stainless steel

Measures

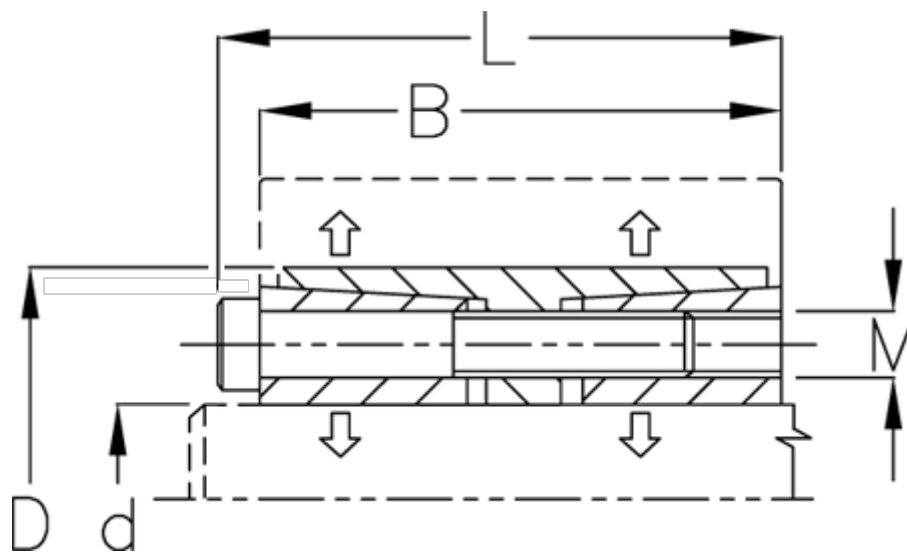

B mm	= 66
d H8 mm	= 65
D mm	= 95
Fit tolerance	= Aksel h8, Nav H8
F kN torque	= 109.0
L mm	= 74
M mm	= M8
P N/mm ² surface pressure on shaft/hub	= 33

Surface roughness	= R? ? 3.2 μm
T N m torque	= 3560
Ts N m bolt tightening torque	= 28.7